

Stars wardrobe - Stars collection

design Bartoli Design



Made to measure wardrobe system clad in a sequence of metal bands, customizable in size and finishes. Available tailor-made with customizable accessories, equipment and internal finishes, and with integrated LED lighting.

Sistema armadio su misura rivestito in una sequenza di strisce di metallo, personalizzabile in dimensioni e finiture. Disponibile su misura con accessori, attrezzature e finiture interne personalizzabili, e con illuminazione LED integrata.



_dimensions

columns

colonne - colonnes - Säulen - колонны

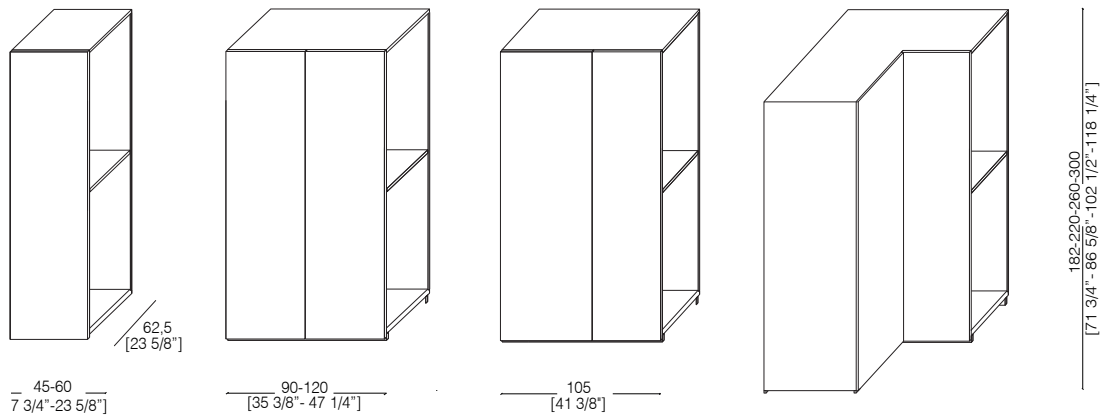

hinged door

vertical stars

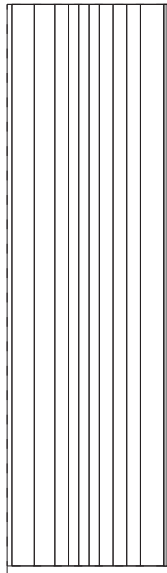

horizontal stars

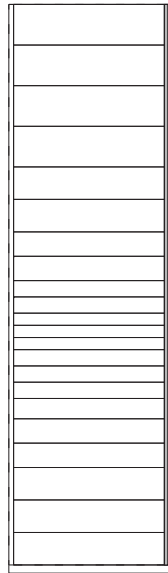

handles for stars doors

handle detail

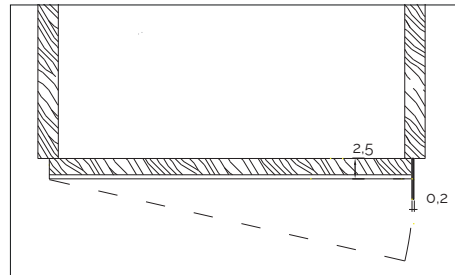

columns handles

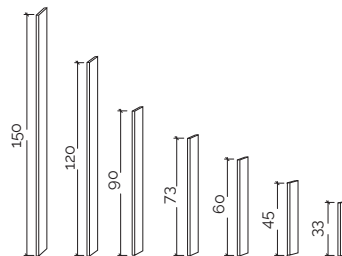

-Dimensions in centimeters and inches.

The right to discontinue and make changes is reserved.

This information is based on the latest product information available at the time of printing.

_dimensions

components

internal drawer
L. 34 / 49 / 79 / 94 / 109
H. 10 / 14,5 / 19 / 28

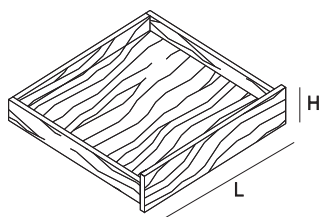

internal drawer with crystal front
L. 34 / 49 / 79 / 94 / 109
H. 10 / 14,5 / 19 / 28

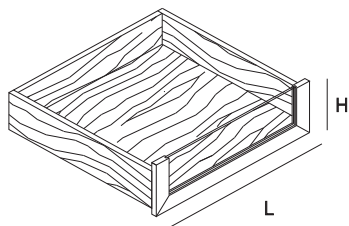

shelf
L. 42,5 / 57,5 / 87,5 / 102,5 / 117,5

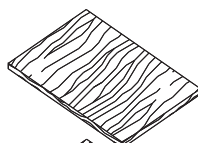

movable shelf

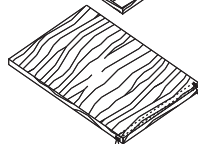

fixed shelf with led

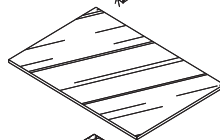

movable acid-etched crystal shelf

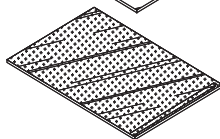

movable smoked glass shelf

-Dimensions in centimeters and inches.
The right to discontinue and make changes is reserved.
This information is based on the latest product information available at the time of printing.

_dimensions

components

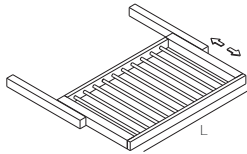

internal trouser rack tray
L. 34 / 49 / 79 / 94 / 109

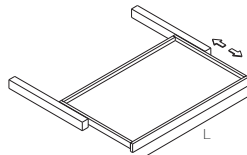

internal pull-out shelf
L. 34 / 49 / 79 / 94 / 109

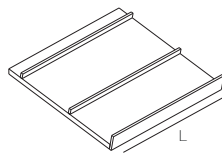

sloping shoe rack shelf
L. 42,5 / 57,5 / 87,5 / 102,5 / 117,5

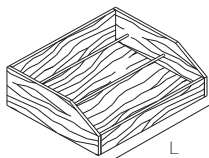

internal shoe rack drawer
L. 34 / 49 / 79 / 94 / 109

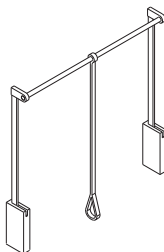

pull down clothes
hanging rail



led bar



power supplier for led bar

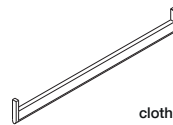

clothes hanging rails



mirror with silver finish
for hinged door

-Dimensions in centimeters and inches.
The right to discontinue and make changes is reserved.
This information is based on the latest product information available at the time of printing.

_dimensions

element for corner high storage unit

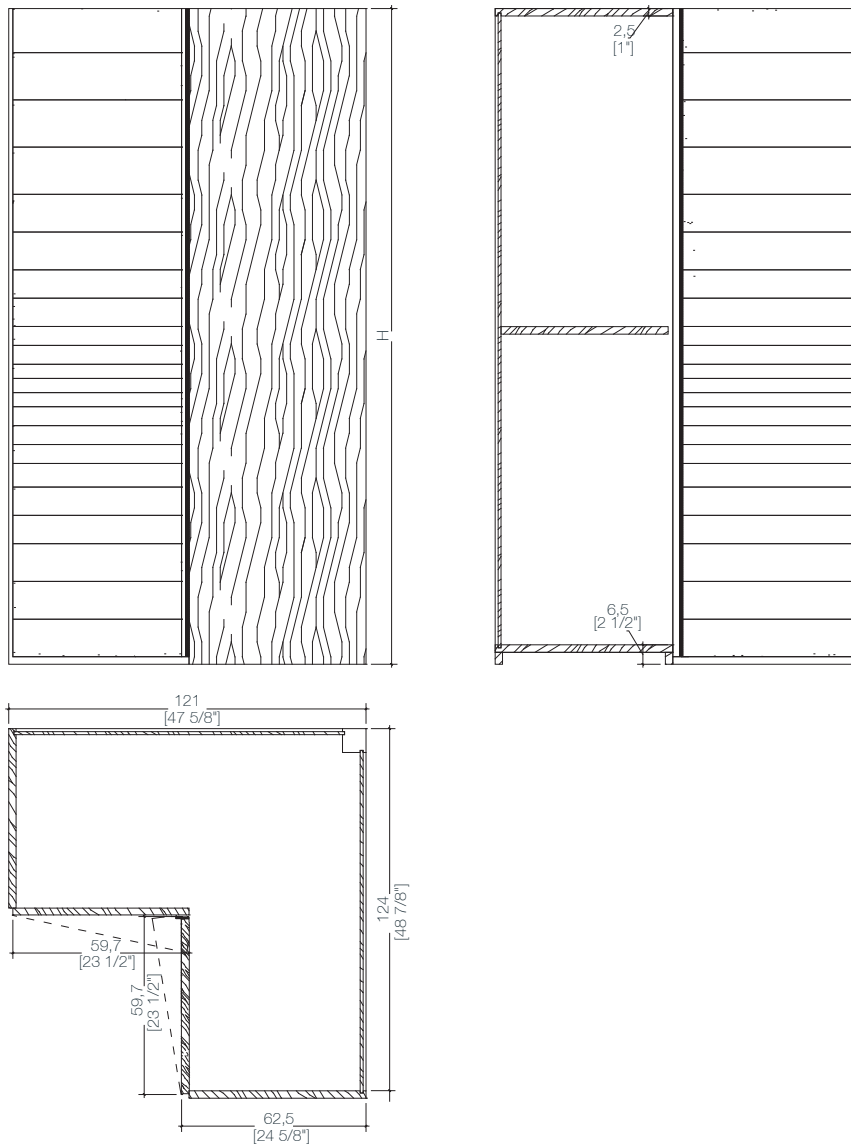

-Dimensions in centimeters and inches.
The right to discontinue and make changes is reserved.
This information is based on the latest product information available at the time of printing.

_dimensions

element for hight storage unit

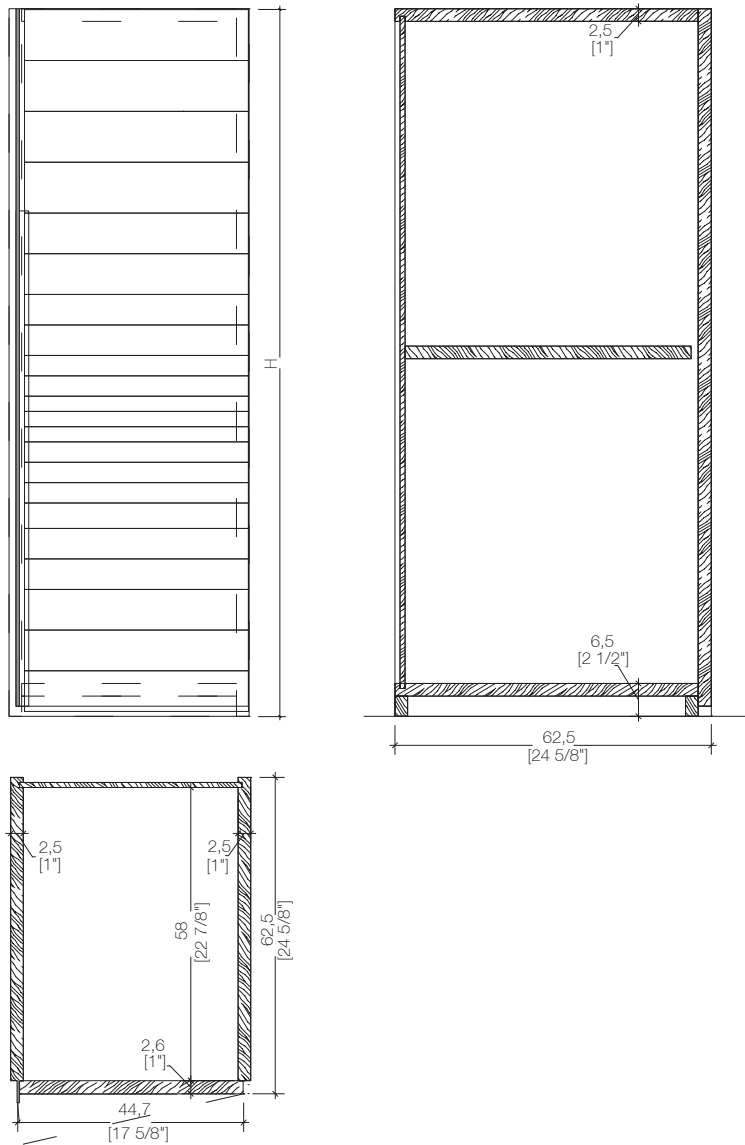

-Dimensions in centimeters and inches.
The right to discontinue and make changes is reserved.
This information is based on the latest product information available at the time of printing.

_materials & finishes

metals stars



Polished Steel



Satin brass



Burnished brass



Satin copper



Burnished copper



Black Iron "Cenere"

_The finishes shown are indicative and refer to the entire production range.
Laurameroni reserves the right to modify the range without warning.

_maintenance

METAL & LIQUID METAL

To maintain the natural features of the metal and to protect the specific craftsmanship from oxidation and discoloration, the metal surfaces are coated with a high-quality transparent varnish. Do not use acid cleaners, solvents or alkalis. Do not use abrasive agents, steel wool, pot cleaners, glass cleaners, aggressive solvents, dyes, bleach or the like. Pointed or sharp objects, such as blades or knives, can cause damage to the surface. Anything hot or humid can cause surface damage.

For cleaning and care, remove light dirt with a soft cloth and a neutral household cleaning product well diluted in water. Gently clean the metal parts by hand with cold or warm water and dry immediately with a soft cloth.

METALLO & METALLO LIQUIDO

Per mantenere il carattere naturale del metallo e tutelare la specifica lavorazione artigianale da ossidazione e scolorimento, le superfici metalliche sono rivestite con una vernice trasparente di alta qualità.

Non utilizzare detergenti acidi, solventi o alcali. Non usare agenti abrasivi, lana d'acciaio, detergenti per pentole, detergenti per vetri, solventi aggressivi, coloranti, candeggina o simili. Oggetti appuntiti o taglienti, come lame o coltelli, possono causare danni alla superficie. Qualsiasi cosa calda o umida può causare danni alla superficie.

Per la pulizia e la cura, rimuovere lo sporco leggero con un panno morbido ed un prodotto neutro per la pulizia della casa abbondantemente diluito in acqua.

Pulire delicatamente a mano le parti metalliche con acqua fredda o tiepida ed asciugare immediatamente con un panno morbido.

**BEDIF
FEREN
TBEUN
IQUE.**

LAURAMERONI s.r.l.
22040 Alzate Brianza (Como)
Via Manzoni, 2784
T +39 031 761450
info@laurameroni.com
www.laurameroni.com