

## Maxima wardrobe - Maxima collection

design Bartoli Design

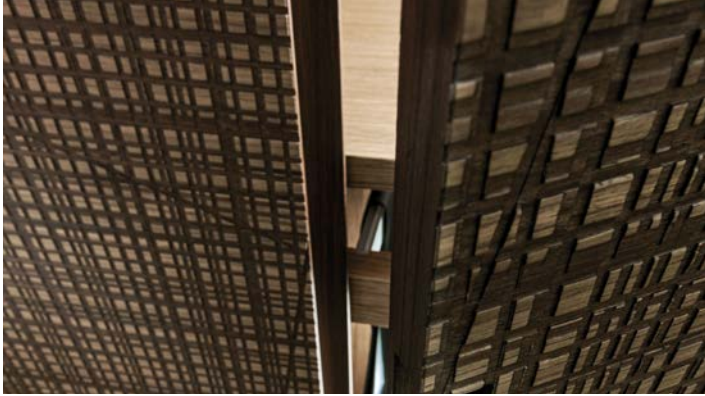

— Made to measure wardrobe system with random Maxima carving, customizable in size and finishes. Available as tailor-made with custom accessories, equipment and internal finishes, and with integrated LED lighting.

— Sistema armadio su misura con scolpitura casuale Maxima, personalizzabile in dimensioni e finiture. Disponibile su misura con accessori, attrezzature e finiture interne personalizzabili, e con illuminazione LED integrata.



\_dimensions

columns

colonne - colonnes - Säulen - колонны

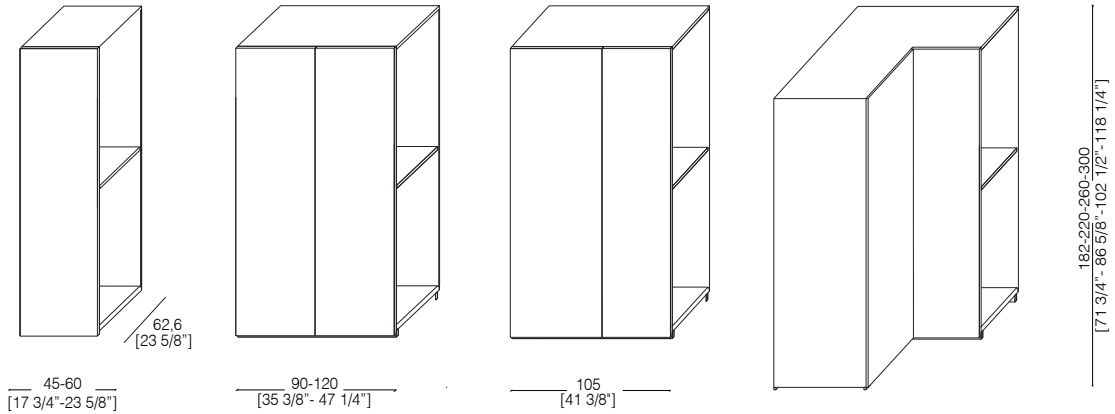

maxima carved wood

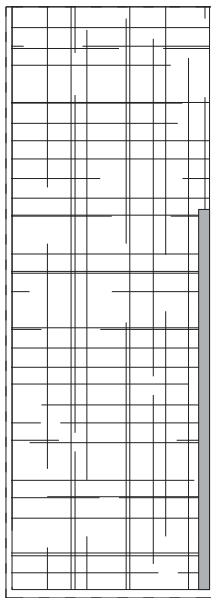

handles detail

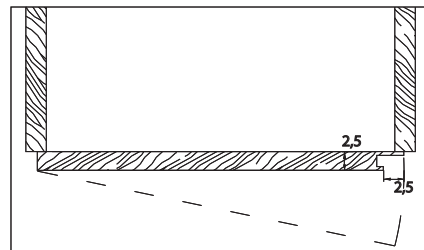

columns handles

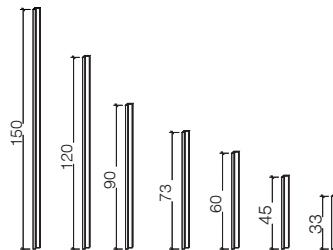

-Dimensions in centimeters and inches.  
The right to discontinue and make changes is reserved.  
This information is based on the latest product information available at the time of printing.

\_dimensions

components

internal drawer

L. 34 / 49 / 79 / 94 / 109  
H. 10 / 14,5 / 19 / 28

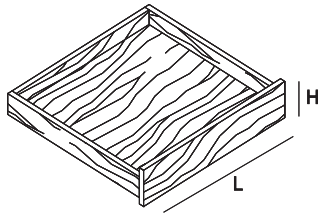

internal drawer with crystal front

L. 34 / 49 / 79 / 94 / 109  
H. 10 / 14,5 / 19 / 28

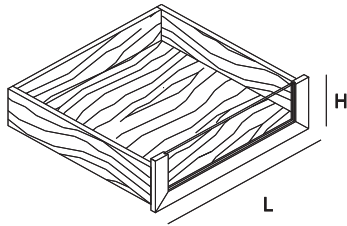

shelf

L. 42,5 / 57,5 / 87,5 / 102,5 / 117,5

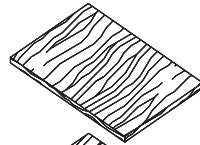

movable shelf

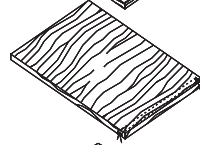

fixed shelf with led

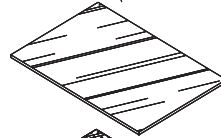

movable acid-etched crystal shelf

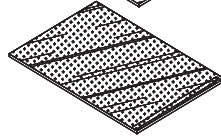

movable smoked glass shelf

-Dimensions in centimeters and inches.  
The right to discontinue and make changes is reserved.  
This information is based on the latest product information available at the time of printing.

\_dimensions

components

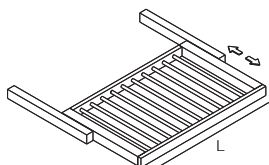

internal trouser rack tray  
L. 34 / 49 / 79 / 94 / 109

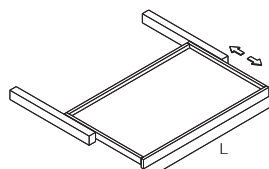

internal pull-out shelf  
L. 34 / 49 / 79 / 94 / 109

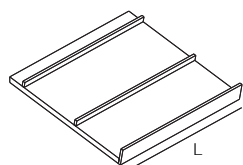

sloping shoe rack shelf  
L. 42,5 / 57,5 / 87,5 / 102,5 / 117,5

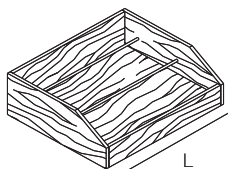

internal shoe rack drawer  
L. 34 / 49 / 79 / 94 / 109

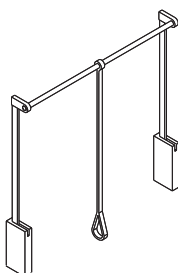

pull down clothes  
hanging rail

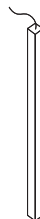

led bar



power supplier for led bar

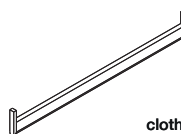

clothes hanging rails

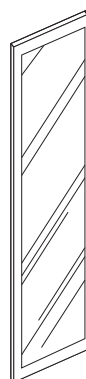

mirror with silver finish  
for hinged door

-Dimensions in centimeters and inches.  
The right to discontinue and make changes is reserved.  
This information is based on the latest product information available at the time of printing.

\_dimensions

element for high storage unit

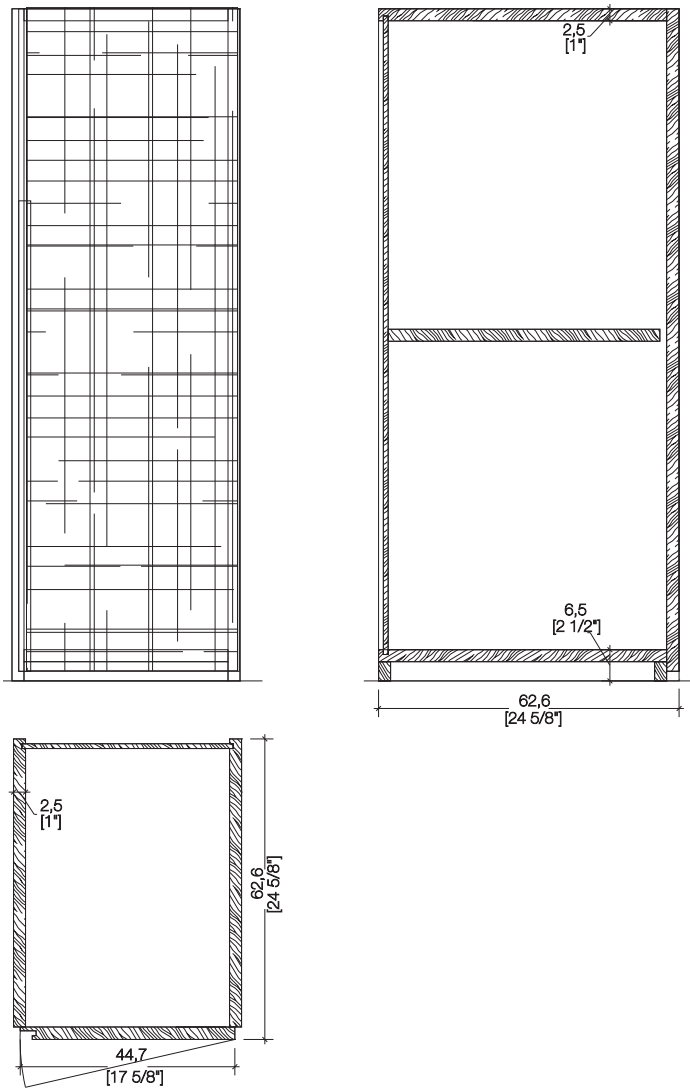

-Dimensions in centimeters and inches.  
The right to discontinue and make changes is reserved.  
This information is based on the latest product information available at the time of printing.

\_dimensions

element for corner high storage unit

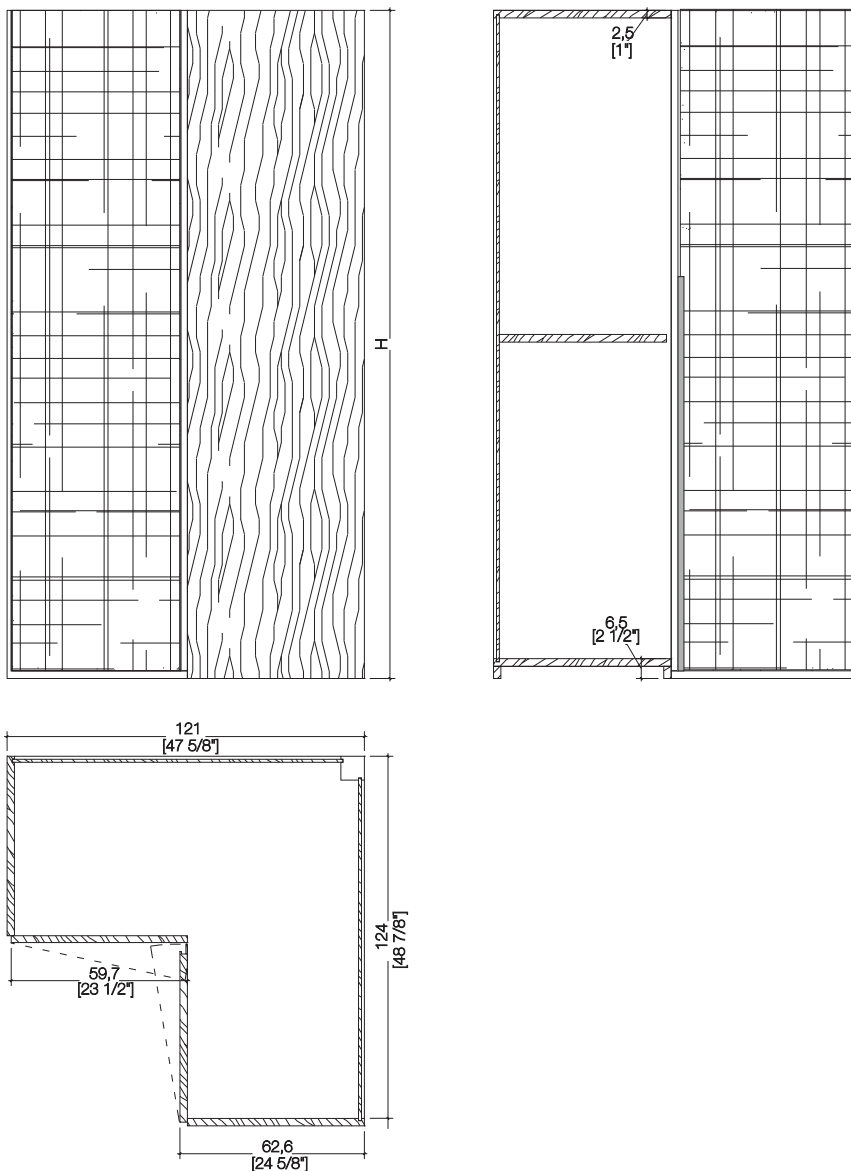

-Dimensions in centimeters and inches.  
The right to discontinue and make changes is reserved.  
This information is based on the latest product information available at the time of printing.

\_materials & finishes

Maxima carving



Maple



Oak



Teak



Walnut Canaletto

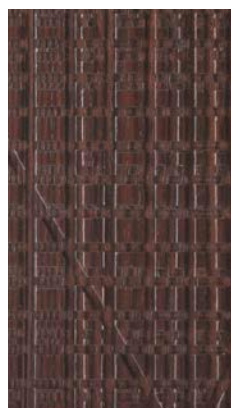

Rosewood



Wenge

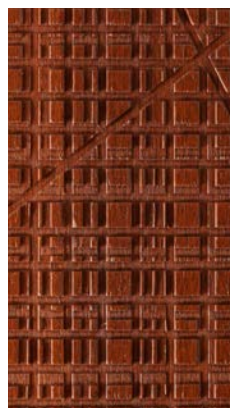

Mahogany



Aniline dyed



Available in all  
RAL / NCS colors

\_The finishes shown are indicative and refer to the entire production range.  
Laurameroni reserves the right to modify the range without warning.

\_materials & finishes

Liquid Metal Maxima



Liquid Metal Bronze



Liquid Metal Tin



Liquid Metal Copper



Liquid Metal Gold 9k

\_The finishes shown are indicative and refer to the entire production range.  
Laurameroni reserves the right to modify the range without warning.



\_materials & finishes

Maxima Metallic Varnish



Lacquered Bronze



Lacquered Tin

\_The finishes shown are indicative and refer to the entire production range.  
Laurameroni reserves the right to modify the range without warning.

\_maintenance

**WOOD**

To maintain the natural wood features and protect them from mechanical and chemical wear, the veneered surfaces are coated with a high-quality transparent varnish. Do not use acid or alkaline detergents, agents with bleaching additives, abrasive powders, steel wool, sponges or the like. Anything hot or humid can cause surface damage. Remove dirt and liquids immediately.

For the cleaning and care, it is best to use a soft, dry cloth. If necessary, the cloth can be slightly dampened and dipped in neutral detergent thoroughly diluted in water. The cloth should only be slightly damp to avoid discoloration or swelling of the surface. Finally, it is essential to gently rub dry surfaces, so that there is no residual moisture.

**LEGNO**

Per mantenere il carattere naturale del legno e proteggerlo dall'usura meccanica e chimica, le superfici impiallacciate sono rivestite con una vernice trasparente di alta qualità. Non usare detergenti acidi o alcalini, agenti con additivi sbiancanti, polveri abrasive, lana d'acciaio, spugne o simili. Qualsiasi cosa calda o umida può causare danni alla superficie. Rimuovere immediatamente sporco e liquidi. Per la pulizia e la cura, è preferibile utilizzare un panno morbido e asciutto. Eventualmente il panno può essere leggermente inumidito ed intinto in detergente neutro abbondantemente diluito in acqua. Il panno deve essere solo leggermente umido, per evitare scolorimenti o rigonfiamenti della superficie. È infine essenziale strofinare gentilmente le superfici asciutte, in modo che non sussista umidità residua.

\_maintenance

#### **METAL & LIQUID METAL**

To maintain the natural features of the metal and to protect the specific craftsmanship from oxidation and discoloration, the metal surfaces are coated with a high-quality transparent varnish. Do not use acid cleaners, solvents or alkalis. Do not use abrasive agents, steel wool, pot cleaners, glass cleaners, aggressive solvents, dyes, bleach or the like. Pointed or sharp objects, such as blades or knives, can cause damage to the surface. Anything hot or humid can cause surface damage.

For cleaning and care, remove light dirt with a soft cloth and a neutral household cleaning product well diluted in water. Gently clean the metal parts by hand with cold or warm water and dry immediately with a soft cloth.

#### **METALLO & METALLO LIQUIDO**

Per mantenere il carattere naturale del metallo e tutelare la specifica lavorazione artigianale da ossidazione e scolorimento, le superfici metalliche sono rivestite con una vernice trasparente di alta qualità.

Non utilizzare detergenti acidi, solventi o alcali. Non usare agenti abrasivi, lana d'acciaio, detergenti per pentole, detergenti per vetri, solventi aggressivi, coloranti, candeggina o simili. Oggetti appuntiti o taglienti, come lame o coltelli, possono causare danni alla superficie. Qualsiasi cosa calda o umida può causare danni alla superficie.

Per la pulizia e la cura, rimuovere lo sporco leggero con un panno morbido ed un prodotto neutro per la pulizia della casa abbondantemente diluito in acqua.

Pulire delicatamente a mano le parti metalliche con acqua fredda o tiepida ed asciugare immediatamente con un panno morbido.

\_maintenance

**PAINTS, LACQUERINGS AND  
SPECIAL FINISHES**

Do not use acid or alkaline detergents, agents with bleaching additives, abrasive powders, steel wool, sponges or the like. Do not use furniture polish or solvents to care for painted surfaces. Anything hot or humid can cause surface damage. Pointed or sharp objects, such as blades or knives, can cause damage to the surface. For the cleaning and care, regularly wipe the surfaces with a clean, soft, lint-free cloth to remove dust while avoiding abrasion. For soft-finish painted surfaces, use a soft, lint-free, slightly damp cloth. If heavily soiled, painted surfaces can be cleaned with a neutral, silicone-free detergent. Finally, it is essential to gently rub dry surfaces, so that there is no residual moisture.

**TINTE, LACCATURE E FINITURE  
SPECIALI**

Non usare detersivi acidi o alcalini, agenti con additivi sbiancanti, polveri abrasive, lana d'acciaio, spugne o simili. Non utilizzare lucidi per mobili o solventi per la cura delle superfici verniciate. Qualsiasi cosa calda o umida può causare danni alla superficie. Oggetti appuntiti o taglienti, come lame o coltelli, possono causare danni alla superficie. Per la pulizia e la cura, pulire regolarmente le superfici con un panno pulito, morbido e privo di lanugine per rimuovere la polvere evitando l'abrasione. Per le superfici verniciate con finitura morbida, utilizzare un panno soffice, privo di lanugine e leggermente umido. Se molto sporche, le superfici verniciate possono essere pulite con un detersivo neutro privo di silicone. È infine essenziale strofinare gentilmente le superfici asciutte, in modo che non sussista umidità residua.

**BEDIF  
FEREN  
TBEUN  
IQUE.**

LAURAMERONI s.r.l.  
22040 Alzate Brianza (Como)  
Via Manzoni, 2784  
T +39 031 761450  
info@laurameroni.com  
www.laurameroni.com