

ML 51 - Sculture collection

design Leone & Mazzari



Table with wooden structure, featuring a particular three-legged base. Available in square or round version, and made to measure in special dimensions.

Customizable in all the wood essences of the collection and available with integrated lazy-susan.

Tavolo con struttura in legno, caratterizzato da una particolare base a tre gambe. Disponibile nella versione quadrata o rotonda, e su misura in dimensioni speciali.

Personalizzabile in tutte le essenze di legno della collezione e disponibile con lazy-susan integrato.



_dimensions

ML 51 round table - tavolo rotondo -
runder tisch - table ronde - Круглый стол

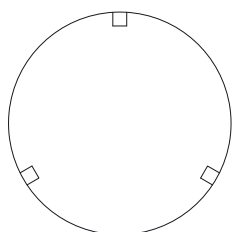
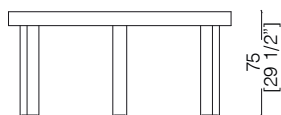

140 - 170 - 200
[55 1/8"] - [67"] - [78 3/4"]

ML 53 square table - tavolo quadrato -
viereckiger tisch - table carrée - Прямоугольный стол

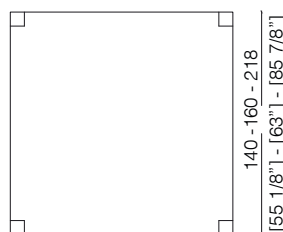

140 - 160 - 218
[55 1/8"] - [63"] - [85 7/8"]

ML 51 LS round table - tavolo rotondo -
runder tisch - table ronde - Круглый стол

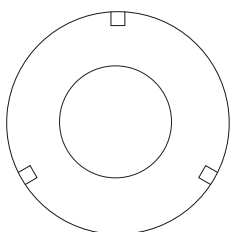
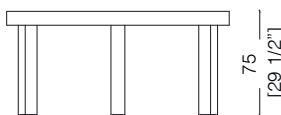

140 - 170 - 200
[55 1/8"] - [67"] - [78 3/4"]

ML 52 rectangular table - tavolo rettangolare -
rechteckiger tisch - table rectangulaire - Прямоугольный стол

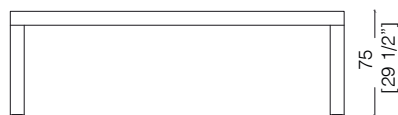

180 - 240 - 320
[70 1/8"] - [94 3/8"] - [126 1/8"]

120
[47 1/4"]

Available in special dimensions.

Dimensions in centimeters and inches.

The right to discontinue and make changes is reserved.

This information is based on the latest product information available at the time of printing.

_assembly instructions

lazy susan

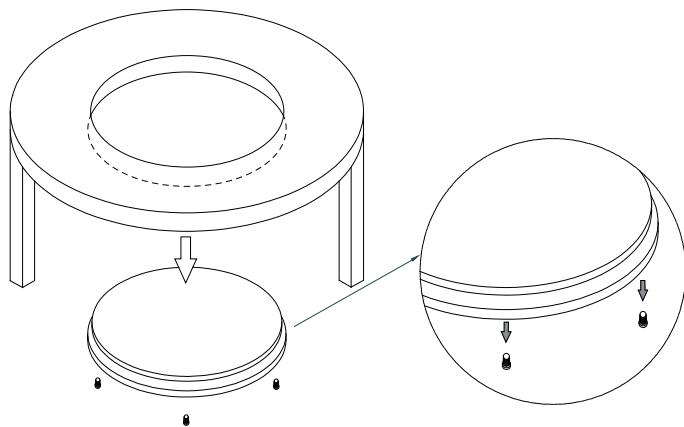

1 Remove bolts fixing the lazy susan to the table top.

_materials & finishes

plain woods



Maple



Oak



Teak



Zebrano



Canaletto Walnut

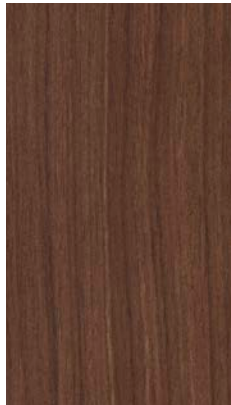

Dyed Canaletto walnut



Ebony



Termocotto Oak



Rosewood



Wenge



Mahogany

_The finishes shown are indicative and refer to the entire production range.
Laurameroni reserves the right to modify the range without warning.

_materials & finishes

dyed woods



Titanium AL1105



Grey AL1106



Sand AL1851



Black AL1853

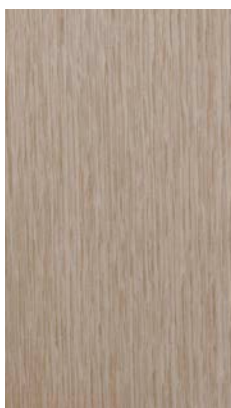

Aniline dyed



Available in all
RAL / NCS colours

_The finishes shown are indicative and refer to the entire production range.
Laurameroni reserves the right to modify the range without warning.

_materials & finishes
special woods



Stone Oak 'Carbone'



Stone Oak 'Tabacco'



'Faggio Antico'



Syberian Ash



Rosewood 'India'



Rosewood 'Santos'



Ziricote



Walnut 'Colore'

_The finishes shown are indicative and refer to the entire production range.
Laurameroni reserves the right to modify the range without warning.

_materials & finishes

lacquering



Brushed matt lacquered



Available in all
RAL / NCS colours

_The finishes shown are indicative and refer to the entire production range.
Laurameroni reserves the right to modify the range without warning.

_maintenance

_PAINTS, LACQUERINGS AND SPECIAL FINISHES

Do not use acid or alkaline detergents, agents with bleaching additives, abrasive powders, steel wool, sponges or the like. Do not use furniture polish or solvents to care for painted surfaces. Anything hot or humid can cause surface damage. Pointed or sharp objects, such as blades or knives, can cause damage to the surface. For the cleaning and care, regularly wipe the surfaces with a clean, soft, lint-free cloth to remove dust while avoiding abrasion. For soft-finish painted surfaces, use a soft, lint-free, slightly damp cloth. If heavily soiled, painted surfaces can be cleaned with a neutral, silicone-free detergent. Finally, it is essential to gently rub dry surfaces, so that there is no residual moisture.

_TINTE, LACCATURE E FINITURE SPECIALI

Non usare detersivi acidi o alcalini, agenti con additivi sbiancanti, polveri abrasive, lana d'acciaio, spugne o simili. Non utilizzare lucidi per mobili o solventi per la cura delle superfici verniciate. Qualsiasi cosa calda o umida può causare danni alla superficie. Oggetti appuntiti o taglienti, come lame o coltelli, possono causare danni alla superficie.

Per la pulizia e la cura, pulire regolarmente le superfici con un panno pulito, morbido e privo di lanugine per rimuovere la polvere evitando l'abrasione. Per le superfici verniciate con finitura morbida, utilizzare un panno soffice, privo di lanugine e leggermente umido. Se molto sporche, le superfici verniciate possono essere pulite con un detersivo neutro privo di silicone. È infine essenziale strofinare gentilmente le superfici asciutte, in modo che non sussista umidità residua.

_maintenance

LEGNO

To maintain the natural wood features and protect them from mechanical and chemical wear, the veneered surfaces are coated with a high-quality transparent varnish. Do not use acid or alkaline detergents, agents with bleaching additives, abrasive powders, steel wool, sponges or the like. Anything hot or humid can cause surface damage. Remove dirt and liquids immediately.

For the cleaning and care, it is best to use a soft, dry cloth. If necessary, the cloth can be slightly dampened and dipped in neutral detergent thoroughly diluted in water. The cloth should only be slightly damp to avoid discoloration or swelling of the surface. Finally, it is essential to gently rub dry surfaces, so that there is no residual moisture.

LEGNO

Per mantenere il carattere naturale del legno e proteggerlo dall'usura meccanica e chimica, le superfici impiallacciate sono rivestite con una vernice trasparente di alta qualità.

Non usare detergenti acidi o alcalini, agenti con additivi sbiancanti, polveri abrasive, lana d'acciaio, spugne o simili. Qualsiasi cosa calda o umida può causare danni alla superficie. Rimuovere immediatamente sporco e liquidi.

Per la pulizia e la cura, è preferibile utilizzare un panno morbido e asciutto. Eventualmente il panno può essere leggermente inumidito ed intinto in detergente neutro abbondantemente diluito in acqua. Il panno deve essere solo leggermente umido, per evitare scolorimenti o rigonfiamenti della superficie. È infine essenziale strofinare gentilmente le superfici asciutte, in modo che non sussista umidità residua.

**BEDIF
FEREN
TBEUN
IQUE.**

LAURAMERONI s.r.l.
22040 Alzate Brianza (Como)
Via Manzoni, 2784
T +39 031 761450
info@laurameroni.com
www.laurameroni.com