

Corteccia pivot door - Corteccia collection

design Laurameroni



—Corteccia, inspired in its simplicity by the barks of evergreen trees, is one of the most modern and artistic Laurameroni textures. The texture, porous and three-dimensional, offers a unique play of brightness and opacity.

—Corteccia, ispirata nella sua semplicità alle cortecce degli alberi sempreverdi, è una delle più moderne ed artistiche texture Laurameroni. La texture, porofonda e tridimensionale, regala un gioco di luminosità ed opacità unico.

_range

Space door

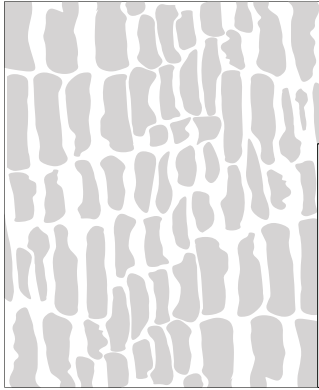

CO 04 pivot door - porta pivot - porte pivotante Pivot
Tür - Дверь pivot

_dimensional limits

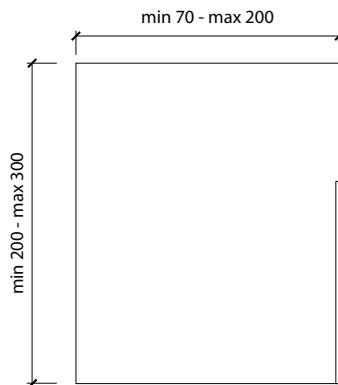

Dimensions in centimeters.

The right to discontinue and make changes is reserved.

This information is based on the latest product information available at the time of printing.

_details

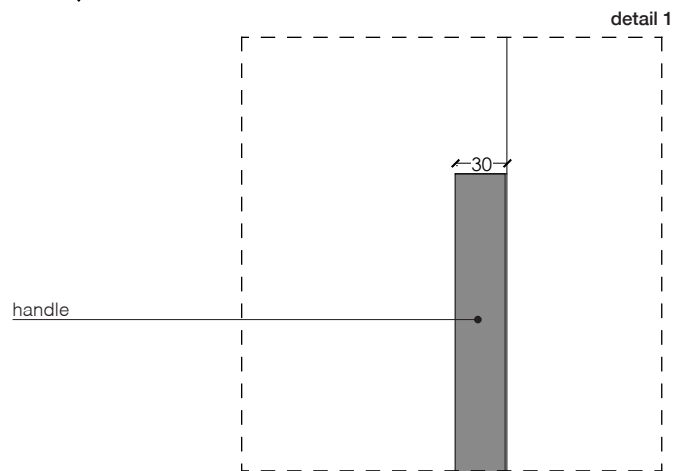
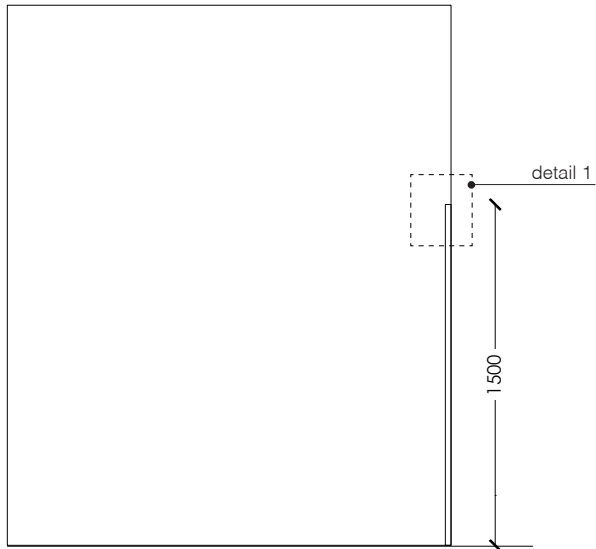

door section

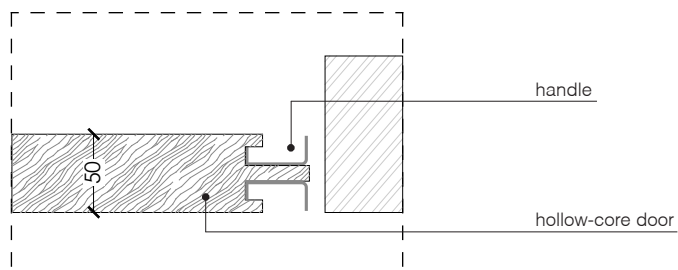

Dimensions in centimeters.

The right to discontinue and make changes is reserved.

This information is based on the latest product information available at the time of printing.

_dimensions

door without doorframe

pivot door

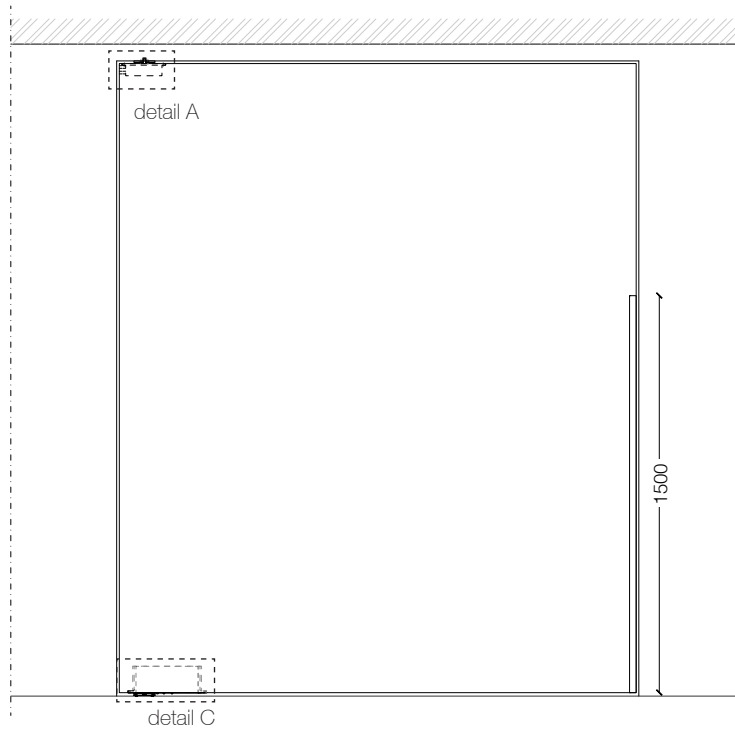

vertical section

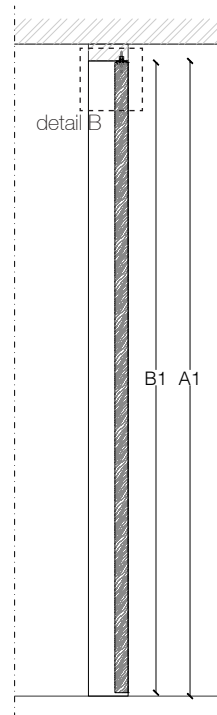

horizontal section

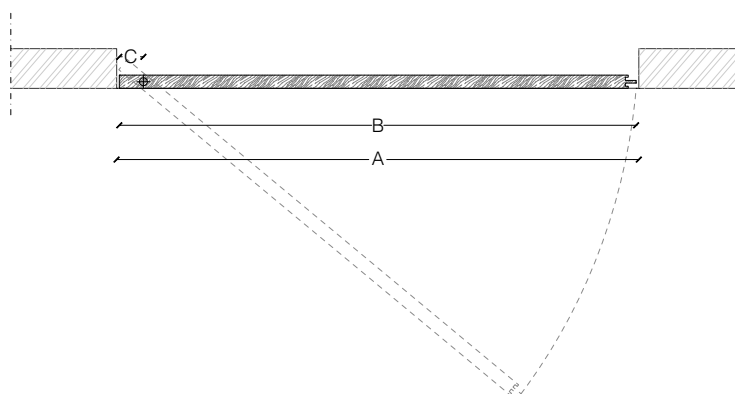

legend

A = door way

B = door

C = min. distance between centres

A - 20 mm
> 91 mm

A1 = door way

B1 = door

A1 - 23 mm

Dimensions in millimeters.

The right to discontinue and make changes is reserved.

This information is based on the latest product information available at the time of printing.

_dimensions

door with doorframe

pivot door

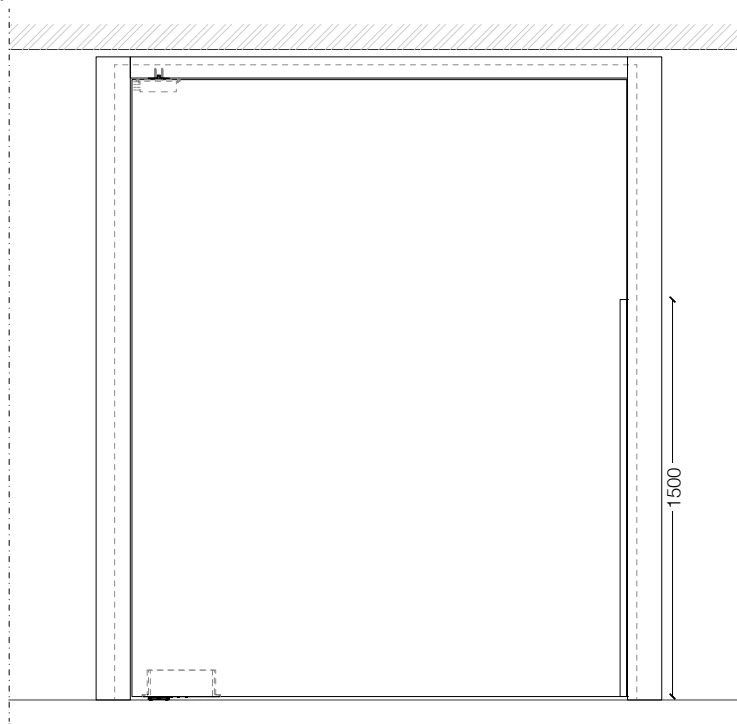

vertical section



horizontal section

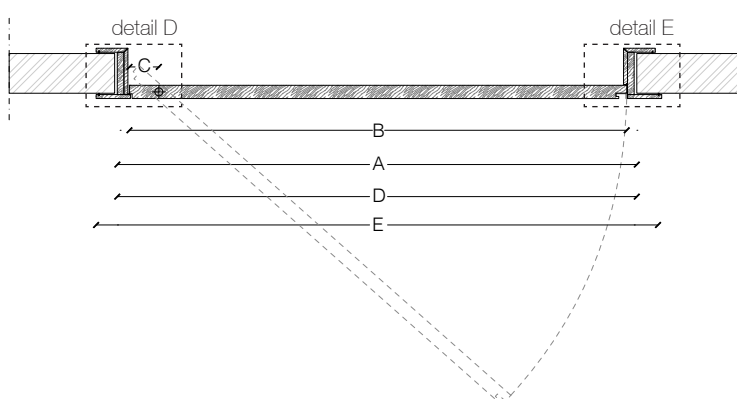

legend

A = door way

B = door

C = min. distance between centres

D = doorframe dimensions

E = covering dimensions

A - 84 mm
B > 91mm

A - 20 mm
A + 150 mm

A1 = door way

B1 = door

D1 = doorframe dimensions

E1 = covering dimensions

A - 70 mm

A - 18 mm

A + 27 mm

Dimensions in millimeters.

The right to discontinue and make changes is reserved.

This information is based on the latest product information available at the time of printing.

_details

detail A

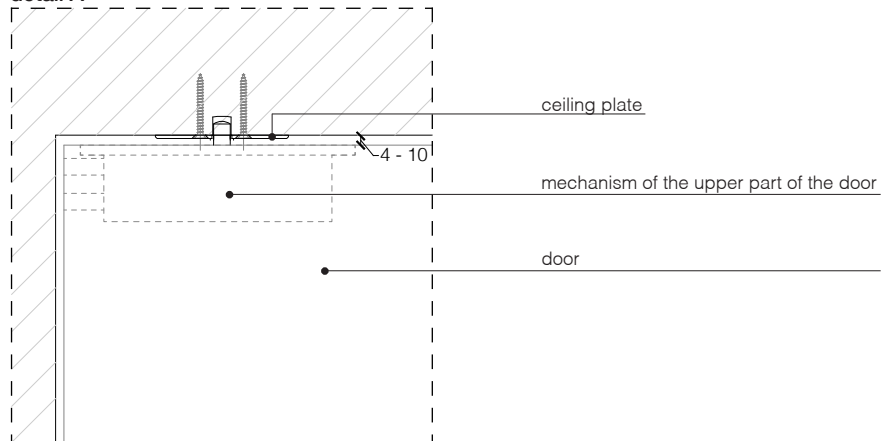

detail B

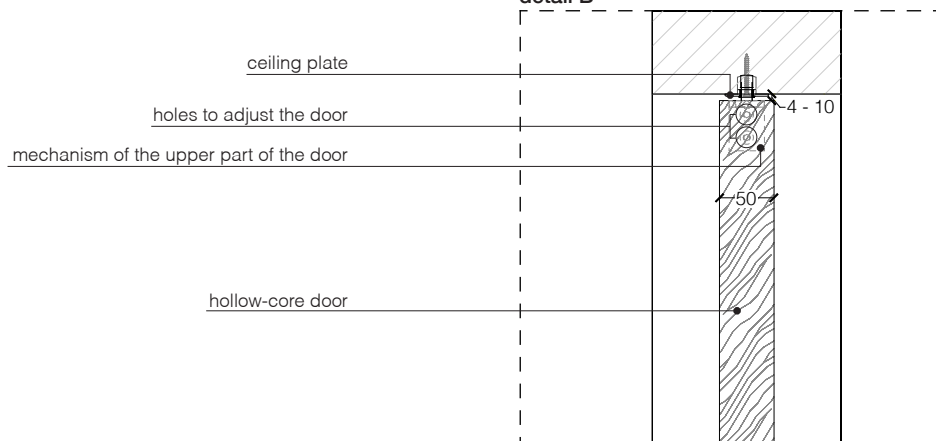

detail C

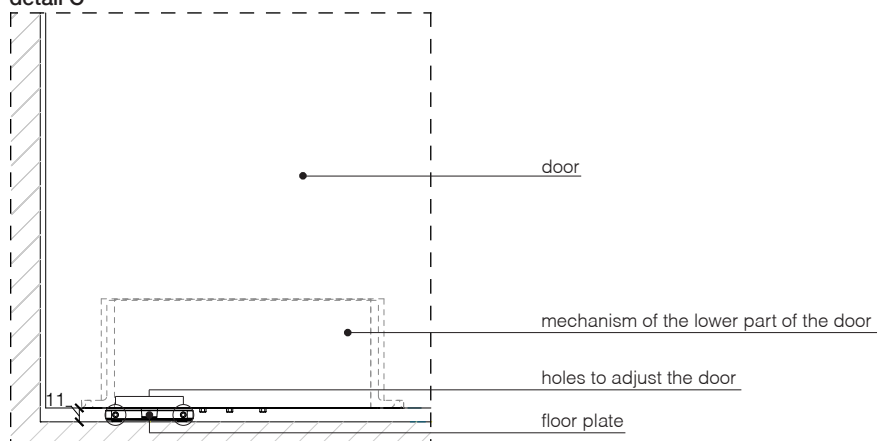

_Dimensions in millimeters.

The right to discontinue and make changes is reserved.

This information is based on the latest product information available at the time of printing.

_details

detail D

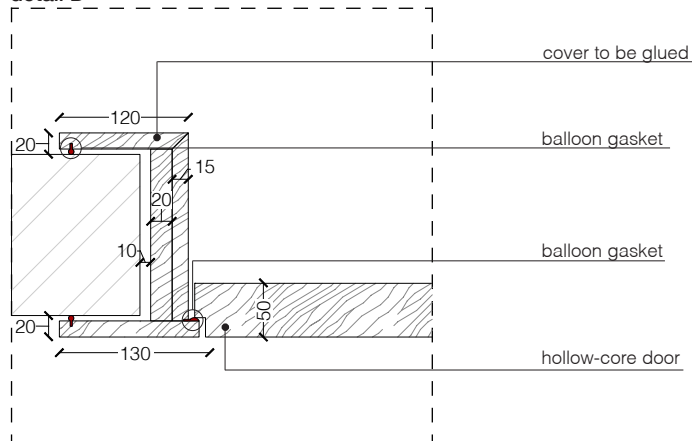

detail E

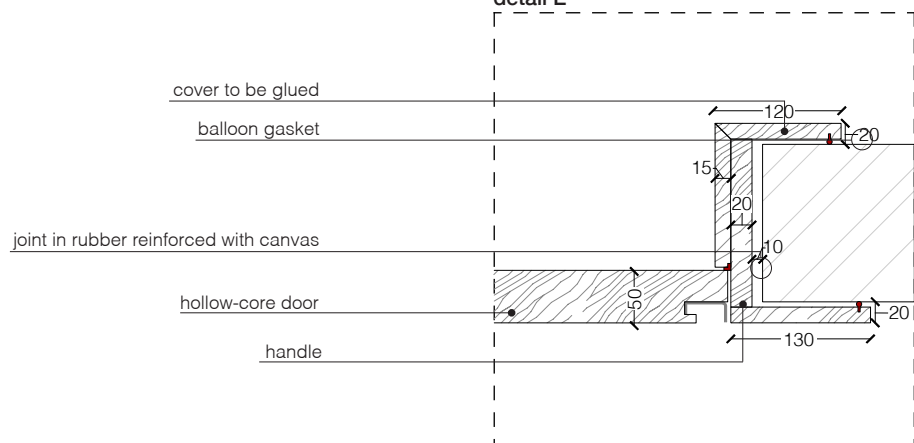

detail F

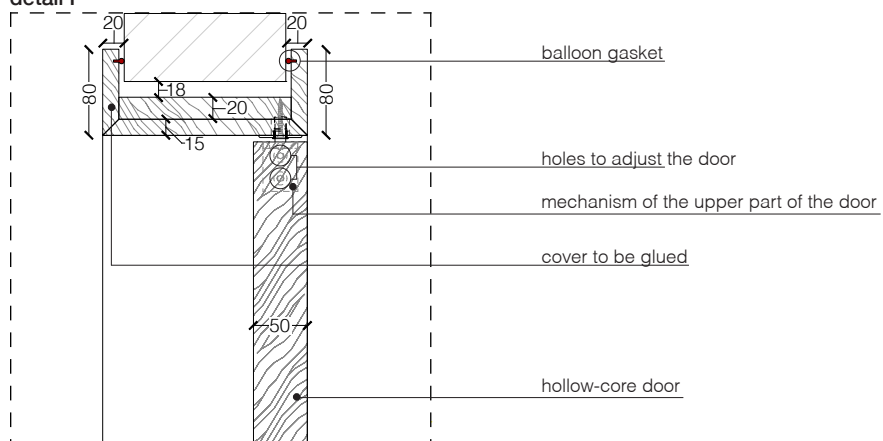

_Dimensions in millimeters.

The right to discontinue and make changes is reserved.

This information is based on the latest product information available at the time of printing.

_materials & finishes

corteccia



Bronze



Tin

**The finishes shown are indicative and refer to the entire production range.
Laurameroni reserves the right to modify the range without warning.**

_maintenance

**PAINTS, LACQUERINGS AND
SPECIAL FINISHES**

Do not use acid or alkaline detergents, agents with bleaching additives, abrasive powders, steel wool, sponges or the like. Do not use furniture polish or solvents to care for painted surfaces. Anything hot or humid can cause surface damage. Pointed or sharp objects, such as blades or knives, can cause damage to the surface. For the cleaning and care, regularly wipe the surfaces with a clean, soft, lint-free cloth to remove dust while avoiding abrasion. For soft-finish painted surfaces, use a soft, lint-free, slightly damp cloth. If heavily soiled, painted surfaces can be cleaned with a neutral, silicone-free detergent. Finally, it is essential to gently rub dry surfaces, so that there is no residual moisture.

**TINTE, LACCATURE E FINITURE
SPECIALI**

Non usare detergenti acidi o alcalini, agenti con additivi sbiancanti, polveri abrasive, lana d'acciaio, spugne o simili. Non utilizzare lucidi per mobili o solventi per la cura delle superfici verniciate. Qualsiasi cosa calda o umida può causare danni alla superficie. Oggetti appuntiti o taglienti, come lame o coltelli, possono causare danni alla superficie. Per la pulizia e la cura, pulire regolarmente le superfici con un panno pulito, morbido e privo di lanugine per rimuovere la polvere evitando l'abrasione. Per le superfici verniciate con finitura morbida, utilizzare un panno soffice, privo di lanugine e leggermente umido. Se molto sporche, le superfici verniciate possono essere pulite con un detergente neutro privo di silicone. È infine essenziale strofinare gentilmente le superfici asciutte, in modo che non sussista umidità residua.

**BEDIF
FEREN
TBEUN
IQUE.**

LAURAMERONI s.r.l.
22040 Alzate Brianza (Como)
Via Manzoni, 2784
T +39 031 761450
info@laurameroni.com
www.laurameroni.com