

## Onda cabinet system - Graffiti collection

design Paolo Rizzato



Cabinet system in wood with Onda carving, made-to-measure in modules of different sizes, with open compartments, LED lighting and customized accessories.

Available in all Onda woods, in brushed matt lacquered wood and in aniline-dyed oak in all the RAL colours.

Sistema armadio in legno con scolpitura Onda disponibile su misura in moduli di diverse dimensioni, con vani a giorno, illuminazione LED ed accessori personalizzati.

Disponibile in tutti i legni Onda, in legno laccato opaco spazzolato ed in rovere tinto anilina in tutti i colori della scala RAL.



## Onda cabinet system - Graffiti collection

design Paolo Rizzato



The Onda day system is a flexible and elegant solution that can be composed in multiple wardrobe versions and combined with integrated wall panels and doors from the same collection.

L'armadio giorno Onda è una soluzione flessibile ed elegante che può essere composta in molteplici declinazioni di armadi e combinata con sistemi boiserie e porte integrate della medesima collezione.

\_dimensions

**bases**

basamenti – piétements – Unterstruktur – Нижний шкаф

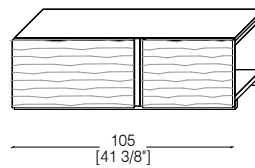
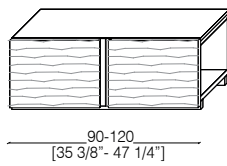
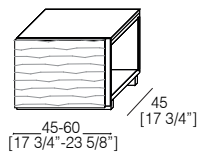

35-75-102  
[13 3/4"-29 1/2"-40 1/4"]

**hanging unit**

pensile – élément mural – hängeschrank- Навесной шкаф

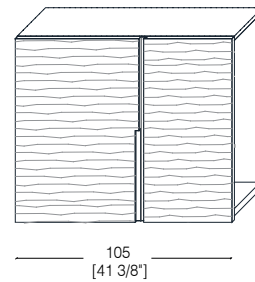
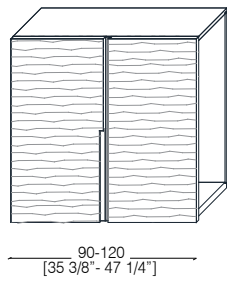
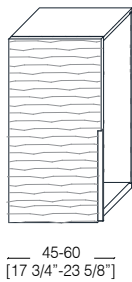

100-140-180  
[39 3/8"-55 1/8"-70 7/8"]

**columns**

colonne – colonnes – Säulen - колонны

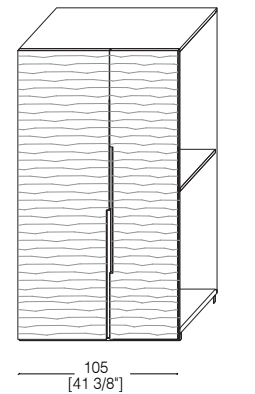
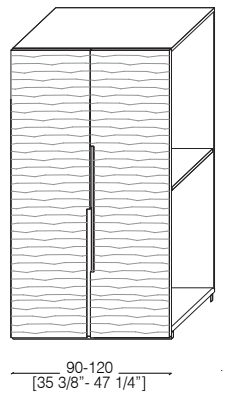
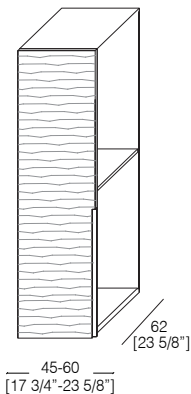

142-182-220-260-300  
[56"-71 3/4"-86 5/8"-102 1/2"-118 1/4"]

-Dimensions in centimeters and inches.

The right to discontinue and make changes is reserved.

This information is based on the latest product information available at the time of printing.

\_dimensions

handles detail

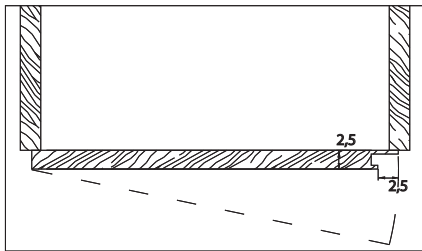

niche  
L. 197,5 / 257,5

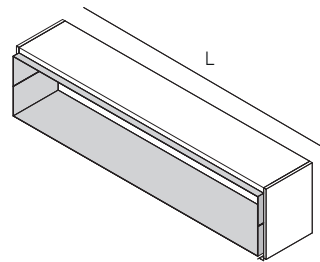

components

internal drawer  
L. 42/57/87/102/117  
H. 10/14/19

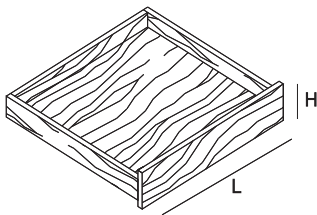

columns handles

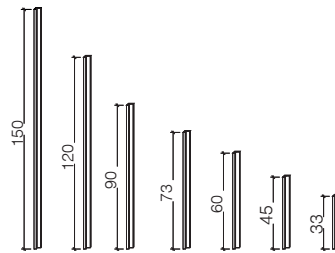

shelf  
L. 42,5 / 57,5 / 87,5 / 102,5 / 117,5

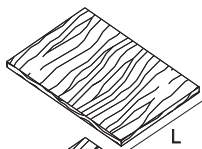

adjustable shelf

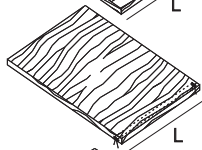

fixed shelf with led

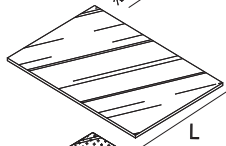

adjustable crystal shelf

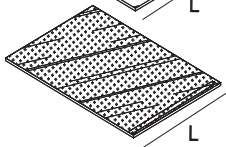

adjustable crystal fumé shelf

-Dimensions in centimeters and inches.  
The right to discontinue and make changes is reserved.  
This information is based on the latest product information available at the time of printing.

\_dimensions

onda carved wood

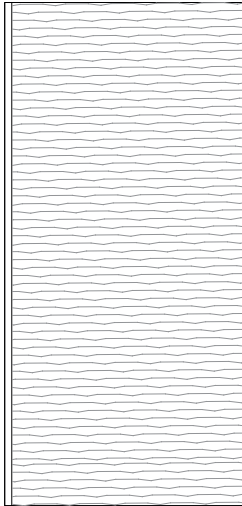

element for base unit

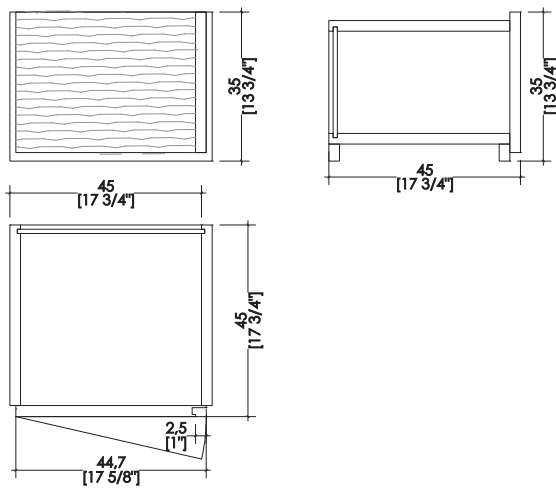

-Dimensions in centimeters and inches.  
The right to discontinue and make changes is reserved.  
This information is based on the latest product information available at the time of printing.

\_dimensions

element for hanging unit

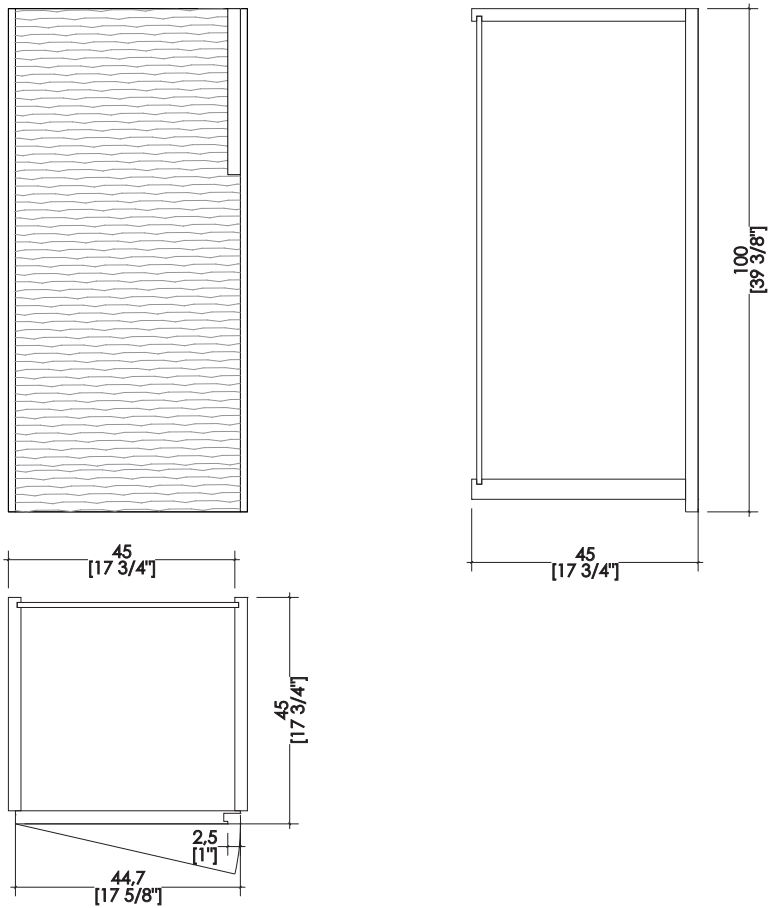

-Dimensions in centimeters and inches.  
The right to discontinue and make changes is reserved.  
This information is based on the latest product information available at the time of printing.

\_dimensions

element for hight storage unit

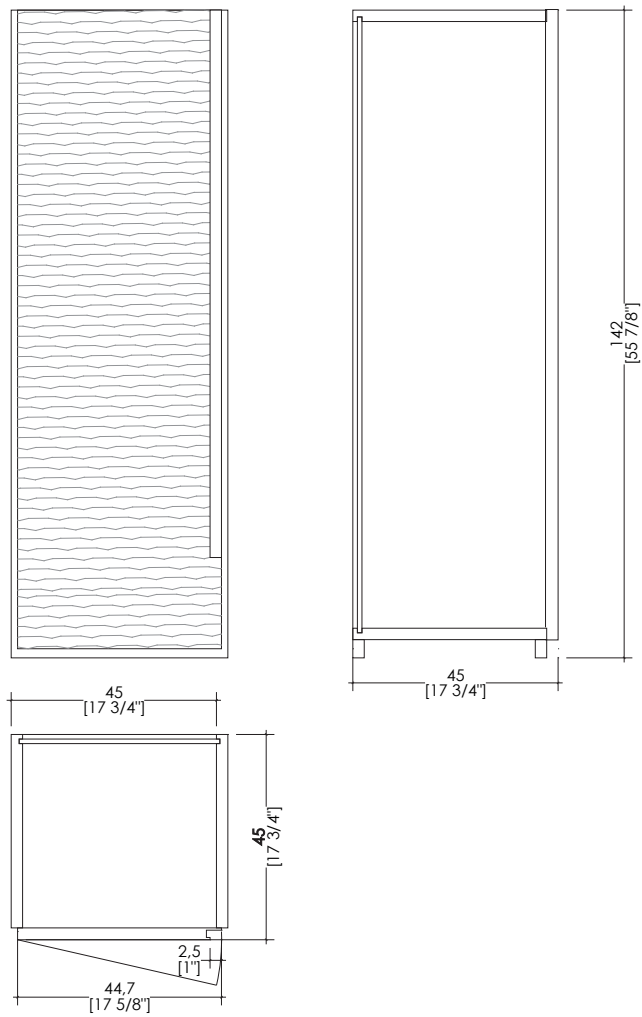

-Dimensions in centimeters and inches.  
The right to discontinue and make changes is reserved.  
This information is based on the latest product information available at the time of printing.

\_dimensions

niche vertical section

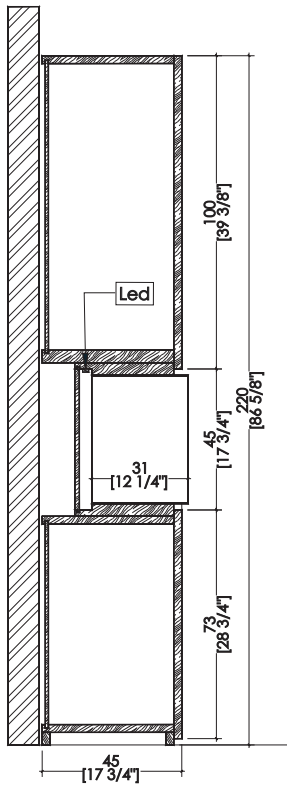

-Dimensions in centimeters and inches.  
The right to discontinue and make changes is reserved.  
This information is based on the latest product information available at the time of printing.



\_materials & finishes

onda carved woods



Maple



Oak



Teak



Canaletto Walnut



Rosewood



Wengé



Mahogany



Anilina RAL 9016



Brushed Matt Lacquered



Available in all  
RAL / NCS colours

\_The finishes shown are indicative and refer to the entire production range.  
Laurameroni reserves the right to modify the range without warning.

\_maintenance

#### **WOOD**

To maintain the natural wood features and protect them from mechanical and chemical wear, the veneered surfaces are coated with a high-quality transparent varnish. Do not use acid or alkaline detergents, agents with bleaching additives, abrasive powders, steel wool, sponges or the like. Anything hot or humid can cause surface damage. Remove dirt and liquids immediately.

For the cleaning and care, it is best to use a soft, dry cloth.

If necessary, the cloth can be slightly dampened and dipped in neutral detergent thoroughly diluted in water. The cloth should only be slightly damp to avoid discoloration or swelling of the surface. Finally, it is essential to gently rub dry surfaces, so that there is no residual moisture.

#### **LEGNO**

Per mantenere il carattere naturale del legno e proteggerlo dall'usura meccanica e chimica, le superfici impiallacciate sono rivestite con una vernice trasparente di alta qualità. Non usare detergenti acidi o alcalini, agenti con additivi sbiancanti, polveri abrasive, lana d'acciaio, spugne o simili. Qualsiasi cosa calda o umida può causare danni alla superficie. Rimuovere immediatamente sporco e liquidi. Per la pulizia e la cura, è preferibile utilizzare un panno morbido e asciutto. Eventualmente il panno può essere leggermente inumidito ed intinto in detergente neutro abbondantemente diluito in acqua. Il panno deve essere solo leggermente umido, per evitare scolorimenti o rigonfiamenti della superficie. È infine essenziale strofinare gentilmente le superfici asciutte, in modo che non sussista umidità residua.

\_maintenance

**PAINTS, LACQUERINGS AND  
SPECIAL FINISHES**

Do not use acid or alkali-based cleaners. Do not use scouring agents, steel wool, pot cleaners or similar. Do not use solvents to clean painted surfaces. Pointed or sharp objects, such as blades or knives, can damage (scratch) the surface. Anything hot or damp will cause damage to the surface. Clean painted surfaces with a clean, soft, lint-free cloth to avoid abrasion with particles of dirt. For soft-finish paint surfaces, use a soft, lint-free, slightly damp cloth. If heavily soiled, paint surfaces can be cleaned more easily with a neutral (silicone-free) cleaning agent. Do not use furniture polish or other care products to clean soft-finish paint surfaces. It is then essential to rub the surface dry, so that there is no residual moisture. Clean painted surfaces regularly with a soft, lint-free cloth to remove dust.

**TINTE, LACCATURE E FINITURE  
SPECIALI**

Non usare detergenti acidi o alcalini, agenti con additivi sbiancanti, polveri abrasive, lana d'acciaio, spugne o simili. Non utilizzare lucidi per mobili o solventi per la cura delle superfici verniciate. Qualsiasi cosa calda o umida può causare danni alla superficie. Oggetti appuntiti o taglienti, come lame o coltelli, possono causare danni alla superficie.

Per la pulizia e la cura, pulire regolarmente le superfici con un panno pulito, morbido e privo di lanugine per rimuovere la polvere evitando l'abrasione. Per le superfici verniciate con finitura morbida, utilizzare un panno soffice, privo di lanugine e leggermente umido. Se molto sporche, le superfici verniciate possono essere pulite con un detergente neutro privo di silicone. È infine essenziale strofinare gentilmente le superfici asciutte, in modo che non sussista umidità residua.

**BEDIF  
FEREN  
TBEUN  
IQUE.**

LAURAMERONI s.r.l.  
22040 Alzate Brianza (Como)  
Via Manzoni, 2784  
T +39 031 761450  
info@laurameroni.com  
www.laurameroni.com